

Varenummer: 4320000241
Beskrivelse: Rota-fix spændelement A 24x50
Rustfast stål

Mål

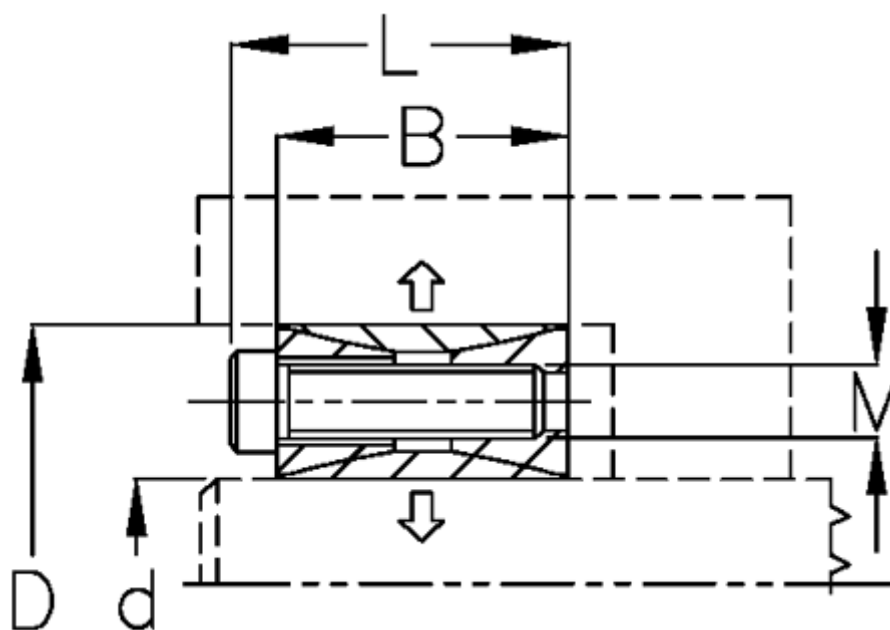

B mm	= 20
d H8 mm	= 24
D mm	= 50
F kN aksialkraft	= 18.8
L mm	= 26
M mm	= M6
Overfladeruhed	= R? ? 3.2 μ m
P N/mm ² fladetryk på aksel/nav	= 33

T Nm drejningsmoment	= 220
Tolerance	= Aksel k11-h11, Nav M6
Ts Nm boltetilspændingsmoment	= 8.8